

XH Lighted Pushbutton Switch

Only 22.5mm depth behind panel with built-in resistor

Sophisticated design with soft and streamlined shape gives excellent panel appearance.

■ FEATURES

- Depth behind panel : Only 22.5mm
- LED Full-Face, Split-Face, Dual-Color Illumination available.
- Hi-Bright LED Super Blue, Super White, Super Green added to Red, Green, Yellow.
- Built-in resistor for 5V,12V,24V use.
- Light Cartridge is removable from front panel.
- Button Size: 19mm square type, 19 × 26mm rectangular type
- Precision-snap action switch movement with coil spring assures long life and outstanding tactile feedback.
- Silver Contact(Gold-Plated) and W/E Alloy #1 Cross-bar Contact provided.
- Accessories: Barriers, Guard Covers, Sockets, etc.

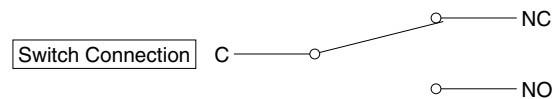
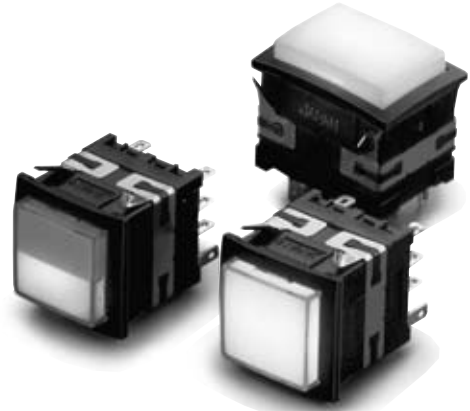

SPECIFICATIONS

Contact	Silver Contact (Gold-Plated)	W/E Alloy #1 Cross-bar Contact
Electrical Rating	AC125V,250V 5A(Resistive)	AC125V0.1A, DC30V 0.1A(Resistive)
Insulation Resistance	More than 100MΩ at 500V DC	
Dielectric Strength	1000V AC RMS between NC and NO terminal 2000V AC RMS between terminals and ground 50/60Hz for 60sec. at normal ambient temperature and humidity	600V AC RMS between NC and NO terminal 2000V AC RMS between terminals and ground 50/60Hz for 60sec. at normal ambient temperature and humidity
Contact Resistance	Less than 30mΩ (Initial) at DC6V 1A	Less than 50mΩ (Initial) at DC6V 0.1A
Mechanical Life	Momentary Action :more than 1,000,000 operations	Alternate Action : more than 200,000 operations
Electrical Life	More than 50,000 operations at max. rated load	More than 100,000 operations at max. rated load
Ambient Temperature	-15°C to +50°C	
Ambient Humidity	80% RH (max.)	

OPERATING CHARACTERISTICS

Operating Force (max.)	4.9N	Total Travel (max.)	3.5mm
------------------------	------	---------------------	-------

STRUCTURE

LIGHT CARTRIDGE

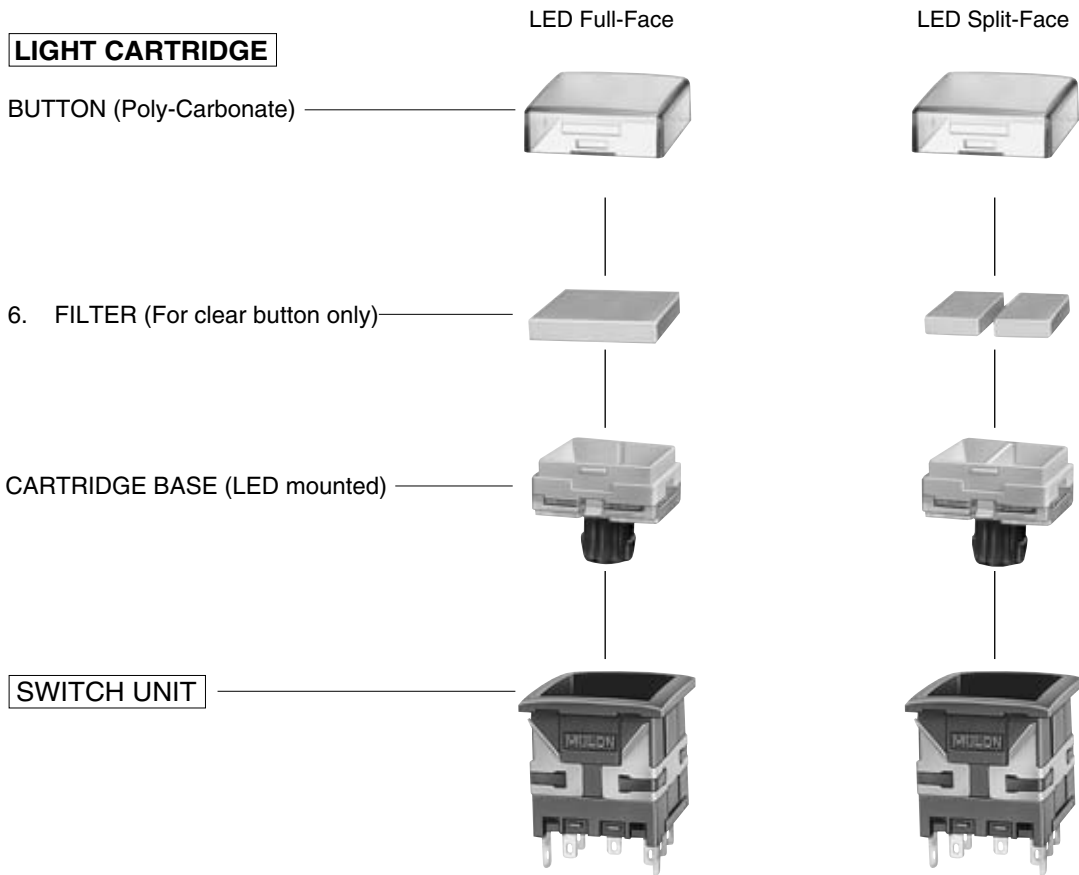

DIMENSIONS

19mm Square Button (Full-Face)				
19×26mm Rect. Button (Full-Face)				

INTERNAL CONNECTION ARRANGEMENTS

● 19mm Square Button

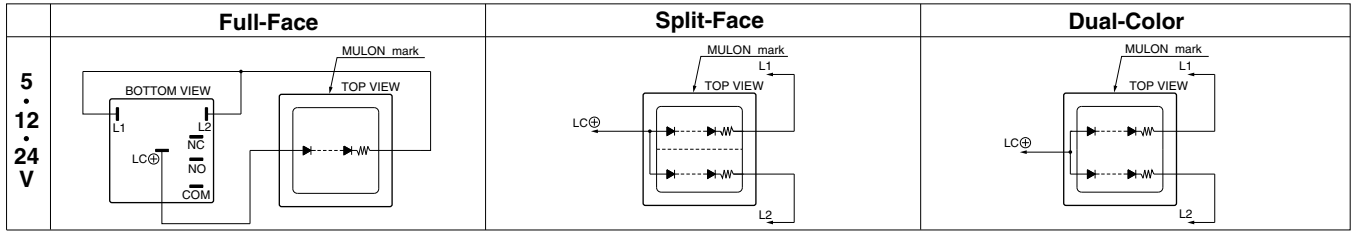

Dual-Color Combination

LC-L1	R	R	Y	SB	SB	SG	R	Y	R	Y	R	Y
LC-L2	G	Y	G	SG	SW	SW	SB	SB	SG	SG	SW	SW

R=Red Y=Yellow G=Green SB=Super Blue SW=Super White SG=Super Green

● 19×26mm Rect. Button

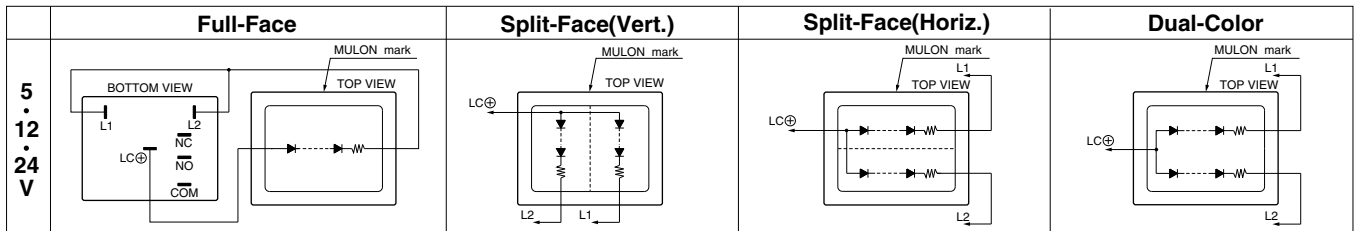

● 19×26mm Rect. Button

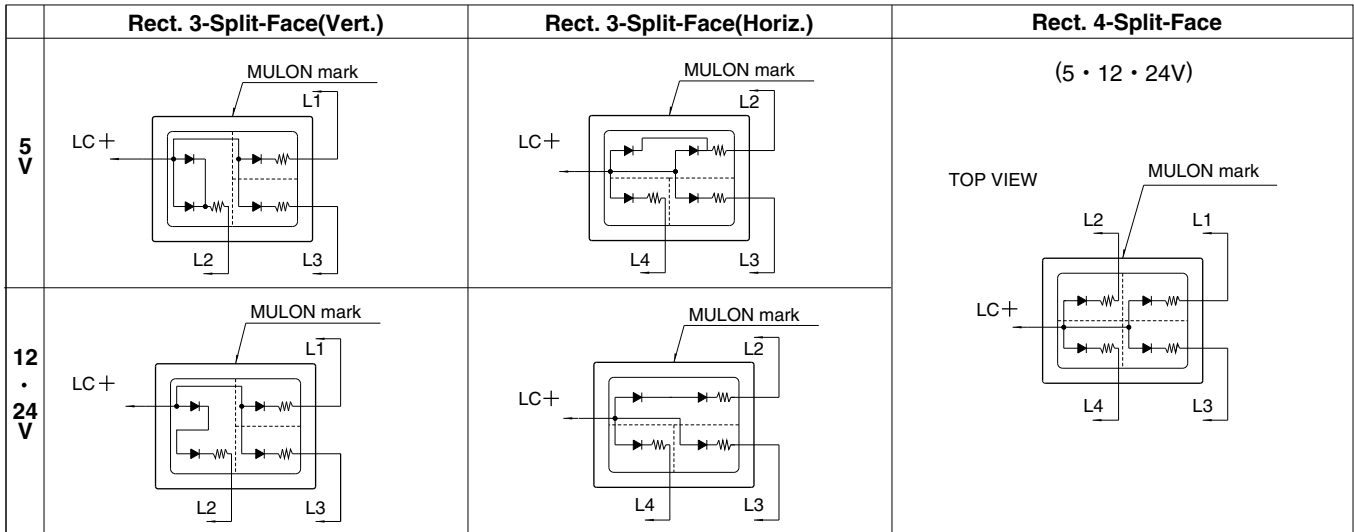

Dual-Color Combination

LC-L1	R	R	Y	SB	SB	SG	SB	SB	SG	SG	SW	SW
LC-L2	G	Y	G	SG	SW	SW	R	Y	R	Y	R	Y

R=Red Y=Yellow G=Green SB=Super Blue SW=Super White SG=Super Green

TERMINALS LAYOUT

● TERMINALS LAYOUT

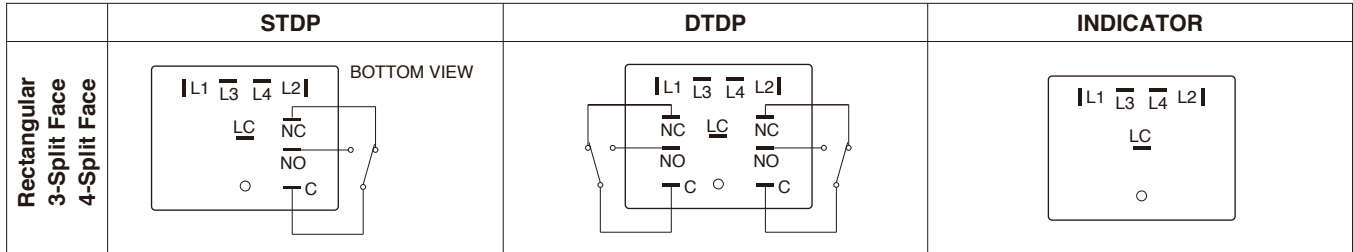
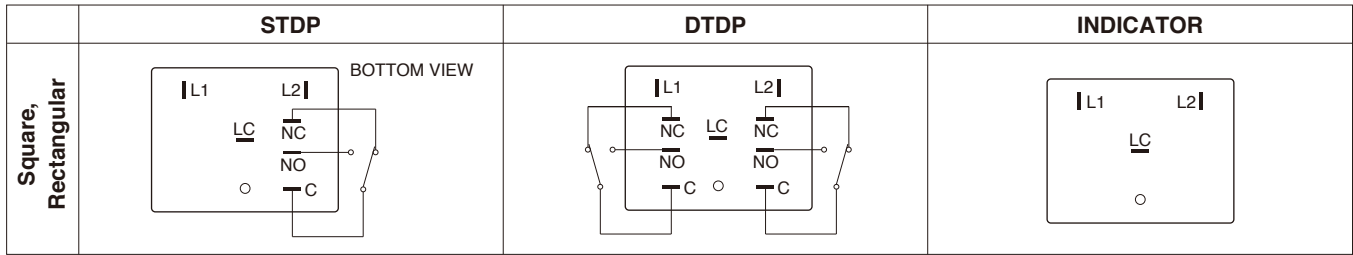

TERMINAL DIMENSIONS

● TERMINAL DIMENSIONS (BOTTOM VIEW)

Full-Face, Split-Face
Dual-Color

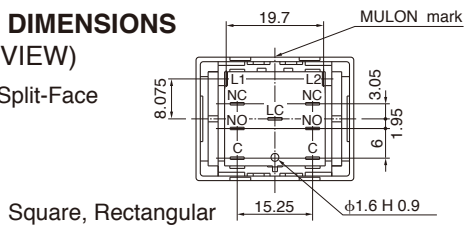

TERMINAL SHAPE

● TERMINAL SHAPE

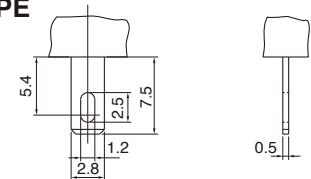

#110 Tab, Soldering Terminal

Tolerance : ±0.4mm

LED DATA

● LED DATA

19mm Square Button	DC Supply Voltage (V)	Current Rating (mA)																						
		Full-Face						Split-Face						Dual-Color										
		R	G	Y	SB	SW	SG	R	G	Y	SB	SW	SG	RGY combination			R,Y and SB, SW, SG combination			SB, SW, SG combination				
														R	G	Y	R	Y	SB	SW	SG	SB	SW	SG
5V	20	52	35	23	20	18	15	32	20	13	10	10	20	52	35	20	35	23	20	18	23	20	18	
12V	15	30	20	13	10	10	8	15	10	13	10	10	15	30	20	15	20	13	10	10	13	10	10	
24V	8	15	10										8	15	10	8	10							

19×26mm Rect. Button	DC Supply Voltage (V)	Current Rating (mA)																												
		Full-Face						Split-Face						Dual-Color						3-Split-Face		4-Split-Face								
		R	G	Y	SB	SW	SG	R	G	Y	SB	SW	SG	RGY combination			R,Y and SB, SW, SG combination			SB, SW, SG combination			RGY	SB, SW, SG	RGY	SB, SW, SG				
														R	G	Y	R	Y	SB	SW	SG	SB					SW	SG		
5V	30	70	45	45	37	33	15	35	23	25	20	18	30	70	45	30	55	45	37	33	45	37	33	45	37	33	10×2, 20×1	10×2, 20×1	10×4	10×4
12V	15	30	20	23	20	18	8	15	9	13	10	10	15	30	20	15	30	23	20	18	23	20	18	23	20	18	10×3	10×3	10×4	10×4
24V	8	17	10	13	10	10							8	17	10	8	10	13	10	10	13	10	10	13	10	10	10×3	10×3	10×4	10×4

LED DATA

● EXTERNAL RESISTOR

Switches are normally fitted with internal resistors to operate on 5, 12, 24V DC supply. In case of non-resistor type, suitable external current limiting resistors must be installed as shown by the table and formula.

★ 19mm Square Button

	Full-Face															Split-Face																				
	R			G			Y			SB			SW			SG			R			G			Y			SB			SW			SG		
	5V	12V	24V	5V	12V	24V	5V	12V	24V	5V	12V	24V	5V	12V	24V	5V	12V	24V	5V	12V	24V	5V	12V	24V	5V	12V	24V	5V	12V	24V	5V	12V	24V	5V	12V	24V
Max. operating current IFM (mA)	60	40	20	60	40	20	60	40	20	40	20	40	20	40	20	40	20	40	20	40	20	40	20	40	20	40	20	20	40	20	20	40	20	20	40	20
DC reverse voltage VR (V)	8	12	24	8	12	24	8	12	24	8	12	24	5	10	5	10	5	10	8	12	8	12	8	12	5	10	5	5	10	5	5	10	5	5	10	5
Forward voltage VF (V)	3.6	5.4	10.8	4.2	6.3	12.6	3.6	5.4	10.8	2.9	5.8	2.9	5.8	2.9	5.8	3	6	3.6	5.4	4.2	6.3	3.6	5.4	2.9	5.8	2.9	5.8	2.9	5.8	2.9	2.9	5.8	2.9	3	6	3
Recommended operating current IF (mA)	20	15	8	40	30	15	25	20	10	23	13	20	10	23	13	15	8	32	15	20	10	20	10	13	10	13	10	10	10	10	10	10	10	10	10	10
Current Reduced Factor	1	0.7	0.4	1	0.7	0.4	1	0.7	0.4	0.6	0.3	0.6	0.3	0.6	0.3	0.6	0.3	0.7	0.4	0.7	0.4	0.7	0.4	0.7	0.4	0.7	0.4	0.7	0.4	0.7	0.4	0.7	0.4	0.3	0.3	0.3
Wiring diagram	Fig. 1															Fig. 2																				

	Dual-Color																																
	RGY combination									R, Y and SB, SW, SG combination									SB, SW, SG combination														
	R			G			Y			R			Y			SB			SW			SG			SB		SW		SG				
	5V	12V	24V	5V	12V	24V	5V	12V	24V	5V	12V	24V	5V	12V	24V	5V	12V	24V	5V	12V	24V	5V	12V	24V	5V	12V	24V	5V	12V	24V			
Max. operating current IFM (mA)	60	40	20	60	40	20	60	40	20	60	40	20	60	40	20	40	20	40	20	40	20	40	20	40	20	40	20	40	20	40	20	40	20
DC reverse voltage VR (V)	8	12	24	8	12	24	8	12	24	8	12	24	8	12	24	5	10	5	10	5	10	8	16	8	16	8	16	5	10	5	5	10	5
Forward voltage VF (V)	3.6	5.4	10.8	4.2	6.3	12.6	3.6	5.4	10.8	3.6	5.4	10.8	2.9	5.8	2.9	5.8	2.9	5.8	3	6	3.6	5.4	4.2	6.3	2.9	5.8	2.9	5.8	2.9	5.8	2.9	5.8	2.9
Recommended operating current IF (mA)	20	15	8	40	30	15	25	20	10	20	15	8	25	20	10	23	13	20	10	23	13	20	10	18	10	23	13	20	10	18	10	18	10
Current Reduced Factor	1	0.7	0.4	1	0.7	0.4	1	0.7	0.4	1	0.7	0.4	1	0.7	0.4	0.6	0.3	0.6	0.3	0.6	0.3	0.6	0.3	0.6	0.3	0.6	0.3	0.6	0.3	0.6	0.3	0.6	0.3
Wiring diagram	Fig. 2																																

★ 19×26mm Rect. Button

	Full-Face															Split-Face																				
	R			G			Y			SB			SW			SG			R			G			Y			SB			SW			SG		
	5V	12V	24V	5V	12V	24V	5V	12V	24V	5V	12V	24V	5V	12V	24V	5V	12V	24V	5V	12V	24V	5V	12V	24V	5V	12V	24V	5V	12V	24V	5V	12V	24V			
Max. operating current IFM (mA)	80	40	20	80	40	20	80	40	20	80	40	20	80	40	20	80	40	20	40	20	40	20	40	20	40	20	40	20	40	20	40	20	40	20	40	20
DC reverse voltage VR (V)	8	16	32	8	16	32	8	16	32	8	16	32	5	10	20	5	10	20	8	16	8	16	8	16	5	10	5	5	10	5	5	10	5	5	10	5
Forward voltage VF (V)	3.6	7.2	14.4	4.2	8.4	16.8	3.6	7.2	14.4	2.9	5.8	11.6	2.9	5.8	11.6	3	6	12	3.6	7.2	4.2	8.4	3.6	7.2	2.9	5.8	2.9	5.8	2.9	5.8	2.9	5.8	2.9	3	6	3
Recommended operating current IF (mA)	30	15	8	70	30	17	45	18	10	45	23	13	37	20	10	33	18	10	15	8	18	15	18	9	18	9	25	13	20	10	25	10	25	10	25	10
Current Reduced Factor	1.4	0.7	0.4	1.4	0.7	0.4	1.4	0.7	0.4	1.1	0.6	0.3	1.1	0.6	0.3	1.1	0.6	0.3	0.7	0.4	0.7	0.4	0.7	0.4	0.7	0.4	0.6	0.3	0.6	0.3	0.6	0.3	0.6	0.3	0.6	0.3
Wiring diagram	Fig. 1															Fig. 2																				

	Dual-Color																																			
	RGY combination									R, Y and SB, SW, SG combination									SB, SW, SG combination																	
	R			G			Y			R			Y			SB			SW			SG			SB		SW		SG							
	5V	12V	24V	5V	12V	24V	5V	12V	24V	5V	12V	24V	5V	12V	24V	5V	12V	24V	5V	12V	24V	5V	12V	24V	5V	12V	24V	5V	12V	24V						
Max. operating current IFM (mA)	80	40	20	80	40	20	80	40	20	80	40	20	80	40	20	80	40	20	80	40	20	80	40	20	80	40	20	80	40	20	80	40	20			
DC reverse voltage VR (V)	8	16	32	8	16	32	8	16	32	8	16	32	8	16	32	5	10	20	5	10	20	8	16	8	16	8	16	5	10	5	5	10	5	5	10	5
Forward voltage VF (V)	3.6	7.2	14.4	4.2	8.4	16.8	3.6	7.2	14.4	3.6	7.2	14.4	2.9	5.8	11.6	2.9	5.8	11.6	3	6	12	3.6	7.2	4.2	8.4	3.6	7.2	2.9	5.8	2.9	5.8	2.9	5.8	2.9	5.8	2.9
Recommended operating current IF (mA)	30	15	8	70	30	17	45	18	10	30	15	8	45	18	10	45	23	13	37	20	10	33	18	10	45	23	13	37	20	10	33	18	10			
Current Reduced Factor	1.4	0.7	0.4	1.4	0.7	0.4	1.4	0.7	0.4	1.4	0.7	0.4	1.4	0.7	0.4	1.1	0.6	0.3	1.1	0.6	0.3	1.1	0.6	0.3	1.1	0.6	0.3	1.1	0.6	0.3	1.1	0.6	0.3	1.1	0.6	0.3
Wiring diagram	Fig. 2																																			

	3-Split-Face												4-Split-Face			
	R, G, Y						SB, SW, SG						RGY		SB, SW, SG	
	5V		12V		24V		5V		12V		24V		5V 12V 24V		5V 12V 24V	
Max. operating current IFM (mA)	20	20	40	20	20	40	20	20	40	20	20	40	20	20	20	20
DC reverse voltage VR (V)	4	4	4	4	8	8	8	8	8	5	5	5	5	5	10	5
Forward voltage VF (V)	3.8	3.8	3.8	3.8	3.8	7.6	3.8	3.8	7.6	2.9	2.9	2.9	2.9	2.9	5.8	2.9
Recommended operating current IF (mA)	10	10	20	10	10	10	10	10	10	10	10	10	10	10	10	10
Current Reduced Factor	0.4	0.7	0.4	0.4	0.4	0.4	0.3	0.6	0.3	0.3	0.3	0.3	0.4	0.3	0.3	0.3
Wiring diagram	Fig. 3												Fig. 4			

Panel Layout / Panel Cut Dimensions

● 19mm Square Button

Panel thickness : 1.0 ~ 4mm

		Panel Layout	Panel Cut Dimensions
Without Barriers	Independent		
	Serial		
With Barriers	Independent		
	Serial		

● 19×26mm Rect. Button

		Panel Layout	Panel Cut Dimensions
Without Barriers	Independent		
	Serial		
With Barriers	Independent		
	Serial		

※ Panel Cut Dimension should be after panel paintings.

※ Vertical serial mounting is not available.

n : number of switches

● In case of group mounting, please leave space as below

	Square Without Barriers	Square With Barriers	Rect. Without Barriers	Rect. With Barriers
Note				

Tolerance : ±0.4mm

ACCESSORIES

BARRIERS

In case of mounting switches in series, barriers can be used to prevent inadvertent pushing neighbor switch.

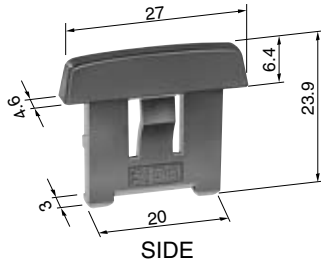

PART NO.		
	Center Barrier	Side Barrier
Black	XH-1872-K	XH-1873-K
Gray	XH-1872-H	XH-1873-H

GUARD COVER

Guard Cover prevents inadvertent and unintentional operations. Easy to install by one-touch, also possible to install after switch be mounted on panel.

- 19mm Square
- 19×26mm Rectangular

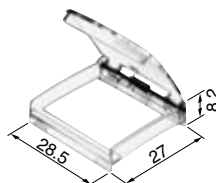
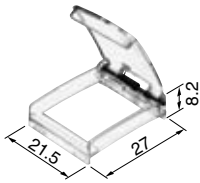

※ The cover to be opened 180° and returned by spring force.

PART NO.	
19mm Square	19×26mm Rectangular
XH-2024	XH-2025

Dust-Proof/Oil Water-tight Cover

Cover, to prevent from Dust, Oil, Water (IP63)

- 19mm Square
- 19×26mm Rectangular

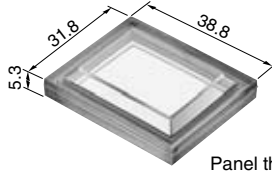
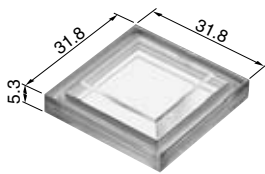

Panel thickness : 1.0 ~ 3.5mm

In case of using for Oil Water-tight, following rubber packing needed. However, it is not effective for serial mounting.

- 19mm Square
- 19×26mm Rectangular

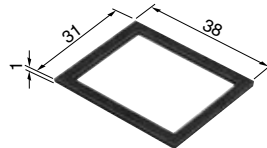
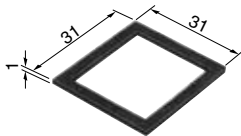

● Panel Cut Dimensions

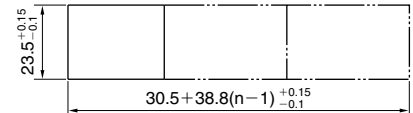
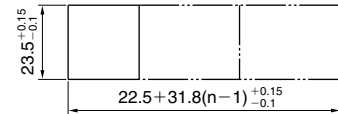

Panel thickness: 1.0 ~ 3.0mm

PART NO.		
	Square	Rectangular
Cover	WH-0783	WH-0784
Rubber packing	WH-0767	WH-0768

SOCKET

For easy maintenance. (Can be used for both square and rectangular)

- Soldering Terminal

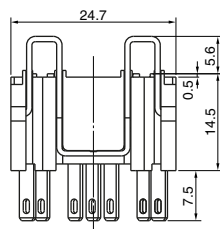

XH-2959-1

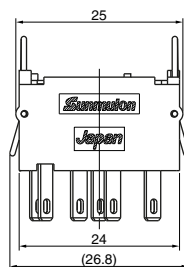

PART NO.	
XH-2959-1	

● TERMINAL DIMENSIONS

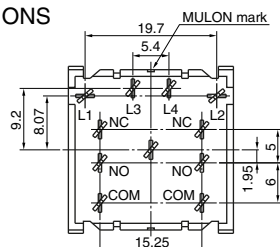

Tolerance : ±0.4mm

FILTER DIMENSIONS

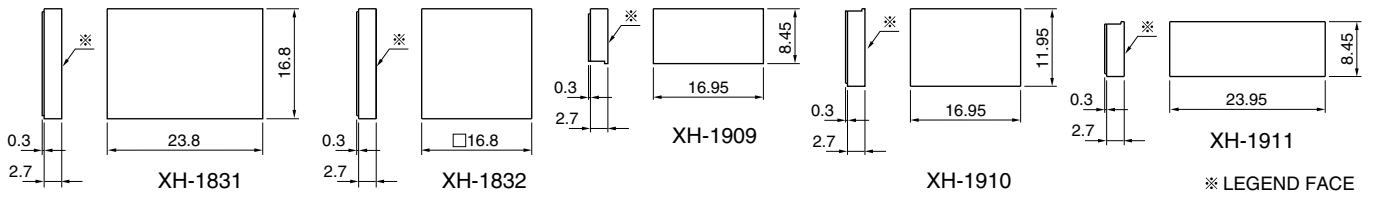

REPLACEMENT PARTS

● **FILTER** For 3 or 4-Split-Face, Please inquiry us how to order.

Item	Square Full-Face	Square Split-Face	Rect. Full-Face	Rect. Split-Face(vertical)	Rect. Split-Face(horizontal)	
color	R	XH-1832-LR	XH-1909-LR	XH-1831-LR	XH-1910-LR	XH-1911-LR
	G	XH-1832-LG	XH-1909-LG	XH-1831-LG	XH-1910-LG	XH-1911-LG
	Y	XH-1832-LY	XH-1909-LY	XH-1831-LY	XH-1910-LY	XH-1911-LY
	Milk-White	XH-1832-LM	XH-1909-LM	XH-1831-LM	XH-1910-LM	XH-1911-LM
	Blue	XH-1832-LB	XH-1909-LB	XH-1831-LB	XH-1910-LB	XH-1911-LB

● **Divider**

	Part No. Position
Square Split-Face	XH-2814
Rect. Split-Face (vertical)	XH-2814
Rect. Split-Face (horizontal)	XH-2889

● **BUTTON**

Item	color	Red	Green	Yellow	Milk-White	Clear	Blue
19mm Square Button		XH-1834-LR	XH-1834-LG	XH-1834-LY	XH-1834-LM	XH-1834-CC	XH-1834-LB
19 × 26mm Rect. Button		XH-1833-LR	XH-1833-LG	XH-1833-LY	XH-1833-LM	XH-1833-CC	XH-1833-LB

ASSEMBLY & DISASSEMBLY

1. Removing Light Cartridge

Hang the cartridge with hooking fingernails in the groove, and pull out.

2. Removing Button

Hook fingernails at A and gently release the clip, and release another side as well.

3. Fitting Filter(s)

Set Filter(s) as shown onto cartridge carefully, then put button on.

4. Fitting Button

Fit the button as shown until click.

5. Fitting Light Cartridge

Insert Light Cartridge into Housing with right direction and push in until click.

6. Installing Barriers (Independent)

Install Side Barriers with Switch as shown.

● **Installing Barriers (Serial)**

Install Side Barriers with Switch and install Center Barrier between Switches.

7. Installing Dust-Proof Cover

1) Put the switch through the cover frame, and mount on panel. Afterwards install soft cover accordingly.

2) In case of Oil and Water-tight use, please apply rubber packing between panel and cover frame.

8. Installing Guard Cover

Just install as shown. It is possible to install after switch be mounted on panel.

ORDERING CODE I

LED Illumination

XH [] - [] [] 1 2 [] [] 1 2 P []

● OPERATION

M	Momentary
A	Alternate
L	Indicator
※ F	Flat Indicator

※ Button level is flat.(locked position)

● CONTACT

0	Indicator
3	SPDT · Silver (Gold-Plated)
4	DPDT · Silver (Gold-Plated)
5	SPDT · W/E Alloy #1Crossbar
6	DPDT · W/E Alloy #1Crossbar

● BUTTON SHAPE · ILLUMINATION TYPE

S0	Square Full-Face
W0	Rect. Full-Face
W1	Rect. Split-Face (Vert.)
S2	Square Split-Face (Horiz.)
W2	Rect. Split-Face (Horiz.)
S3	Square Dual-Color
W3	Rect. Dual-Color
W5	Rect. 3-Split-Face (Vert.)
W6	Rect. 3-Split-Face (Horiz.)
W7	Rect. 4-Split-Face

● Supply Voltage to LED

1	5V
2	12V
3	24V
4	5V Non-Resistor
5	12V Non-Resistor
6	24V Non-Resistor

● FILTER COLOR

1	Red
2	Green
3	Yellow
4	Milk-White
6	Blue
×	Without Filter

Full-Face : Put color no. into the frame 1

Split-Face : Put color no. into the frame 1,2

Dual-Color Put color no. 4 (Milk-White) into the frame 1

● TERMINAL

P	#110 Tab, Soldering
---	---------------------

● HOUSING COLOR

K	Black
H	Gray

● LED COLOR

70	Red	Full-Face : Put color no. into the frame 1 Split-Face : Put color no. into the frame 1,2 Dual-Color Put color no. into the frame 1,2
80	Green	
90	Yellow	
14	Super Blue	Combination: 70·80, 80·90, 90·70 70·14, 70·16, 70·18 90·14, 90·16, 90·18 14·16, 16·18, 18·14
16	Super White	
18	Super Green	

● BUTTON COLOR

R	Red
G	Green
Y	Yellow
M	Milk-White
B	Blue
C	Clear
×	Without Button

※ 1) In case of Split-Face, LED and Filter color location should be specified as follow:

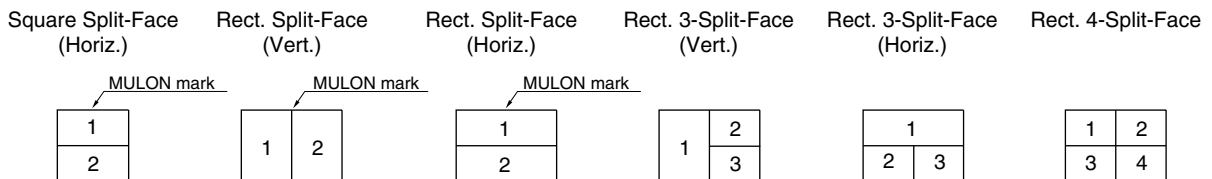

※ 2) In case of Split-Face, button color should be C (clear).

※ 3) In case of Dual-Color, button color should be C (clear) with Milk-White filter or Milk-White button.

※ 4) Please be noted that the color of "Yellow" for LED, Button, Filter is actually "Orange Yellow" not Lemon Yellow.

ORDERING CODE II

XH — 1 2 1 2

● BUTTON SHAPE · ILLUMINATION TYPE

S0	Square Full-Face
W0	Rect. Full-Face
W1	Rect. Split-Face (Vert.)
S2	Square Split-Face (Horiz.)
W2	Rect. Split-Face (Horiz.)
S3	Square Dual-Color
W3	Rect. Dual-Color
W5	Rect. 3-Split-Face (Vert.)
W6	Rect. 3-Split-Face (Horiz.)
W7	Rect. 4-Split-Face

● LED COLOR

70	Red	Full-Face : Put color no. into the frame 1 Split-Face : Put color no. into the frame 1,2 Dual-Color Put color no. 78 into the frame 1,2
80	Green	
90	Yellow	
14	Super Blue	Combination: 70·80, 80·90, 90·70 70·14, 70·16, 70·18 90·14, 90·16, 90·18 14·16, 16·18, 18·14
16	Super White	
18	Super Green	

● BUTTON COLOR

R	Red
G	Green
Y	Yellow
M	Milk-White
B	Blue
C	Clear
×	Without Button

● FILTER COLOR

1	Red
2	Green
3	Yellow
4	Milk-White
6	Blue
×	Without Filter

Full-Face : Put color no. into the frame 1
Split-Face : Put color no. into the frame 1,2
Dual-Color Put color no. 4 (Milk-White) into the frame 1

● Supply Voltage to LED

1	5V
2	12V
3	24V
4	5V Non-Resistor
5	12V Non-Resistor
6	24V Non-Resistor

HOUSING

XH — P

● OPERATION

M	Momentary
A	Alternate
L	Indicator
F	Flat Indicator

※ Button level is flat. (locked position)

● CONTACT

0	Indicator
3	SPDT · Silver (Gold-Plated)
4	DPDT · Silver (Gold-Plated)
5	SPDT · W/E Alloy #1Crossbar
6	DPDT · W/E Alloy #1Crossbar

● BUTTON SHAPE · ILLUMINATION TYPE

S0A	Square Full-Face
W0A	Rect. Full-Face
W1A	Rect. Split-Face (Vert.)
S2A	Square Split-Face (Horiz.)
W2A	Rect. Split-Face (Horiz.)
※ S3A	Square Dual-Color
※ W3A	Rect. Dual-Color
※ S3B	Square Dual-Color (70,90and 14,16,18 combination and among 14,16,18 combination)
※ W3B	Rect. Dual-Color (70,90and 14,16,18 combination and among 14,16,18 combination)
W5A	Rect. 3-Split-Face Rect. 4-Split-Face

● Supply Voltage to LED

1	5V
2	12V
3	24V
4	Non-Resistor

● HOUSING COLOR

K	Black
H	Gray

※Please be noted that Dual-Color type has 2 different code nos. depend on LED color.